

Collapsible Cargo Organizer

1. Release the buckle as shown to remove the straps holding the cargo organizer closed.

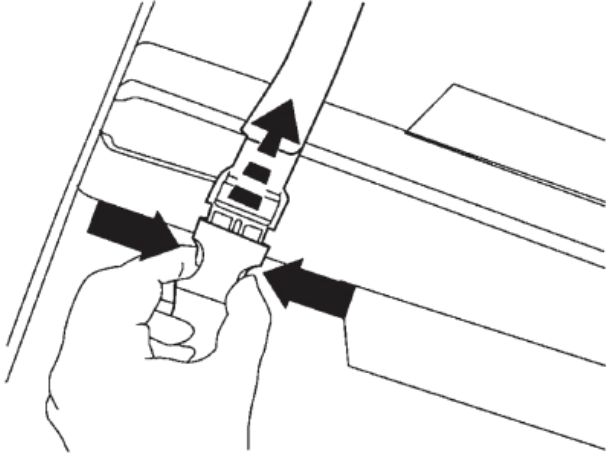

2. Open the cargo organizer.

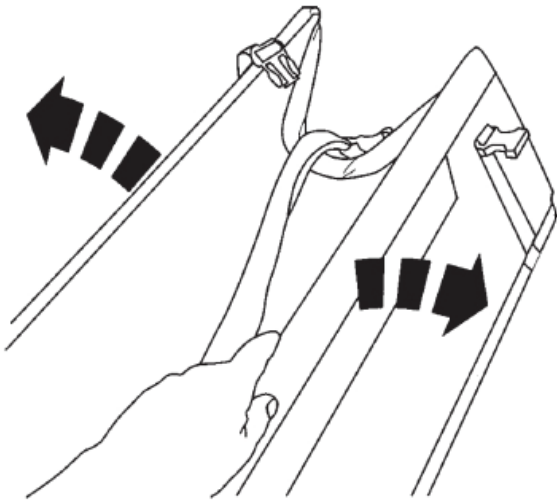

3. Raise the collapsible walls and Velcro the walls together and to the outside of the box to secure the inside compartments.

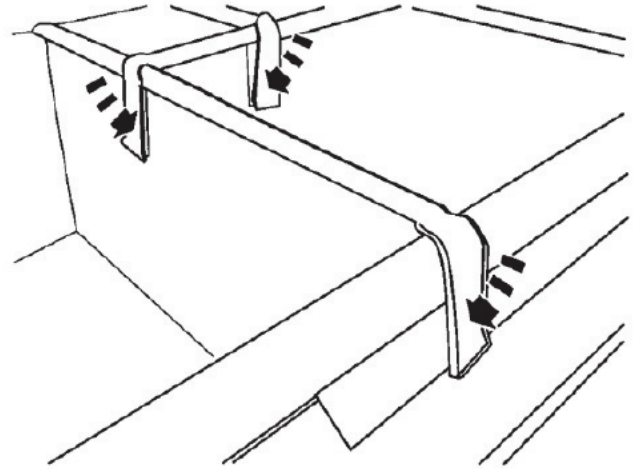

4. Remove the retainer on both sides of the rear compartment wall.

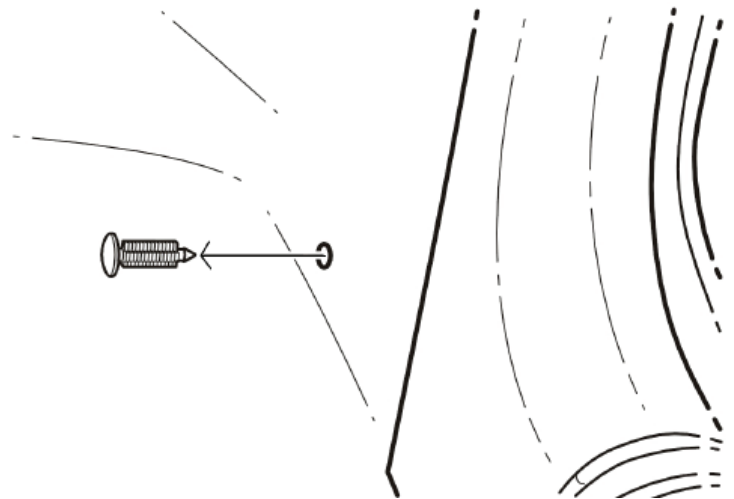

Collapsible Cargo Organizer

IR 21FE11

PART NO.

22827941

SHEET

1 OF 6

ALL INFORMATION WITHIN ABOVE BORDER TO BE PRINTED EXACTLY AS SHOWN ON 8.5 x 11 WHITE 16 POUND NON-BOND RECYCLABLE PAPER. PRINT ON BOTH SIDES, EXCLUDING TEMPLATES. TO BE UNITIZED IN ACCORDANCE WITH GM SPECIFICATIONS.

DATE	REVISION	AUTH	DR
21FE11	Initial Release - Jonathan Pacheco	FCMYJ	

TITLE
INSTALLATION INSTRUCTIONS
Collapsible Cargo Organizer
PART NO. 22827941
SHEET 1 OF 6

5. Install the luggage retainer on both sides of the rear compartment wall.

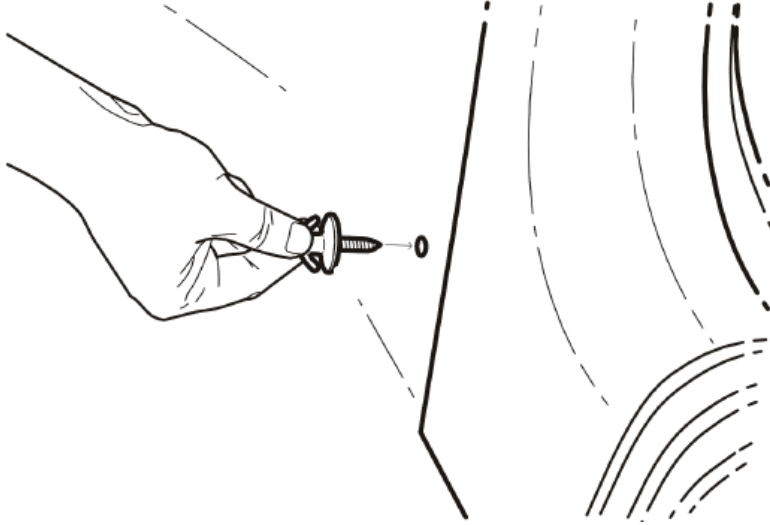

6. Attach the loops to the luggage retainers.

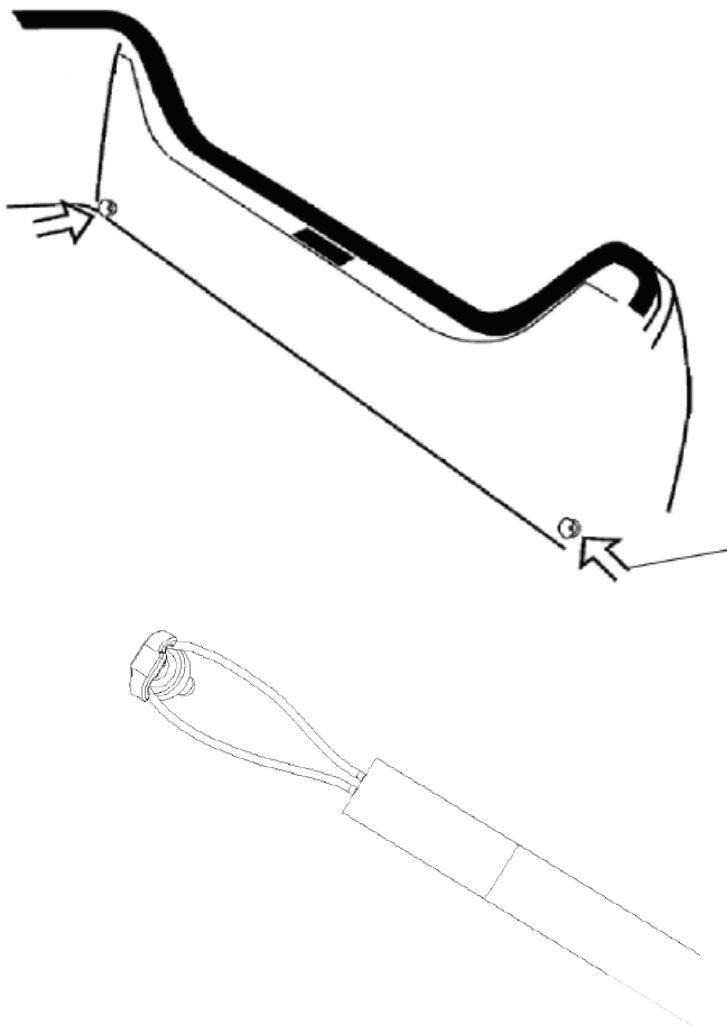

7. To store the cargo organizer, detach the walls and the tie-down or luggage retainers strap to collapse the organizer and reconnect the buckle to hold the cargo organizer closed.

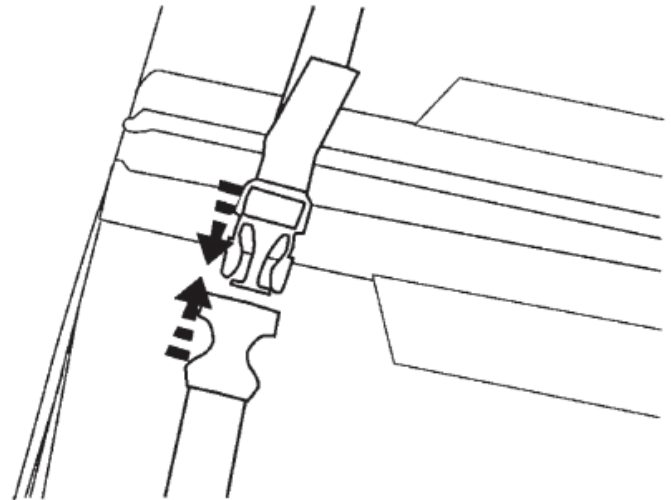

Collapsible Cargo Organizer

IR 21FE11

PART NO.

22827941

SHEET

2 OF **6**

ALL INFORMATION WITHIN ABOVE BORDER TO BE PRINTED EXACTLY AS SHOWN ON 8.5 x 11 WHITE 16 POUND NON-BOND RECYCLABLE PAPER. PRINT ON BOTH SIDES, EXCLUDING TEMPLATES. TO BE UNITIZED IN ACCORDANCE WITH GM SPECIFICATIONS.

DATE	REVISION	AUTH	DR

TITLE

**INSTALLATION INSTRUCTIONS
Collapsible Cargo Organizer**

PART NO.

22827941

SHEET

2 OF **6**

Module de chargement à compartiments repliable

1. Détacher la boucle, comme illustré, afin de retirer les sangles maintenant le module à compartiments de chargement en position fermée.

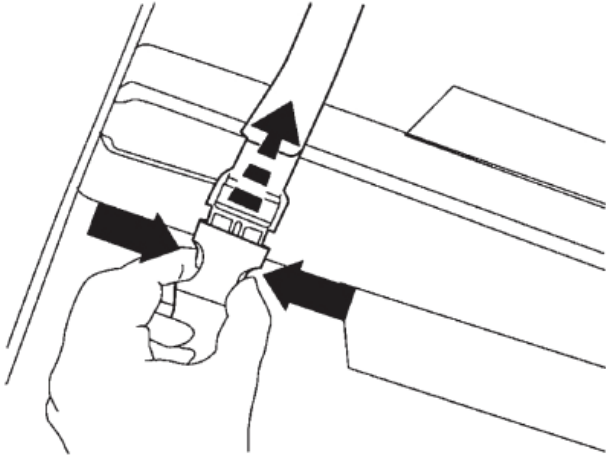

2. Ouvrir le module de chargement.

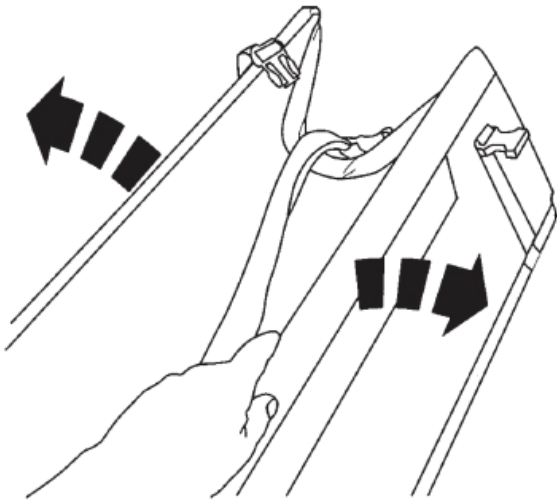

3. Relever les parois rabattables et les fixer avec la bande Velcro, les unes aux autres et à l'extérieur de la boîte, afin d'immobiliser les compartiments intérieurs.

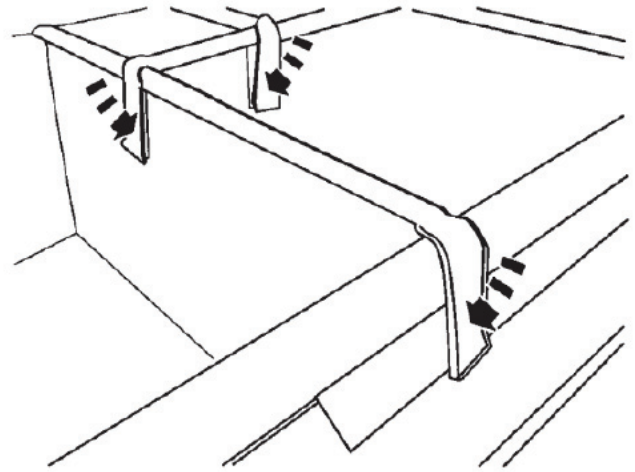

4. Déposer la fixation des deux côtés de la paroi du compartiment arrière.

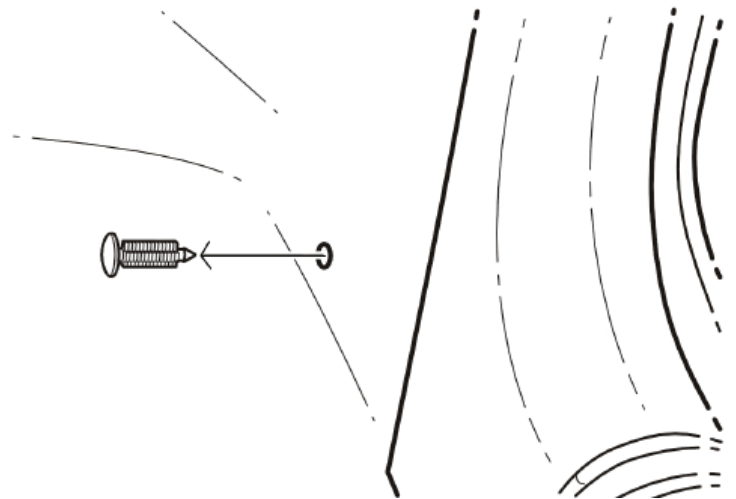

Collapsible Cargo Organizer

IR 21FE11

PART NO.

22827941

SHEET

3 OF **6**

ALL INFORMATION WITHIN ABOVE BORDER TO BE PRINTED EXACTLY AS SHOWN ON 8.5 x 11 WHITE 16 POUND NON-BOND RECYCLABLE PAPER. PRINT ON BOTH SIDES, EXCLUDING TEMPLATES. TO BE UNITIZED IN ACCORDANCE WITH GM SPECIFICATIONS.

DATE	REVISION	AUTH	DR
21FE11	Initial Release - Jonathan Pacheco		

TITLE
INSTALLATION INSTRUCTIONS Collapsible Cargo Organizer
PART NO. 22827941 SHEET 3 OF 6

5. Poser la fixation de bagage des deux côtés de la paroi du compartiment arrière.

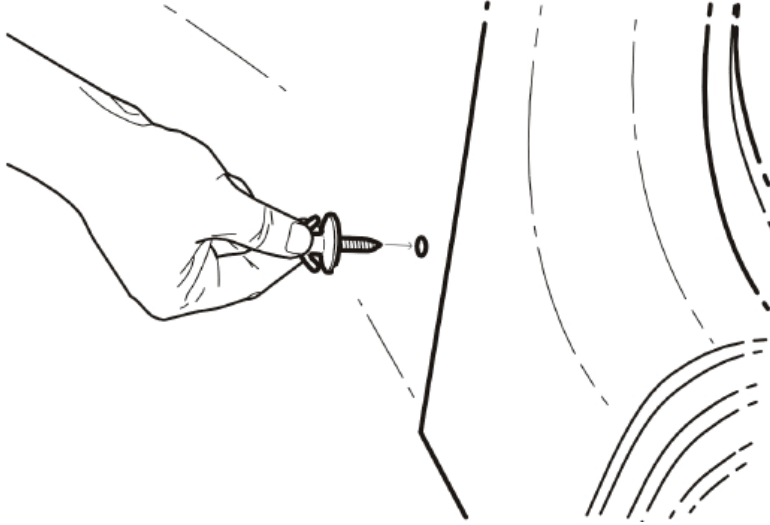

6. Attacher les boucles aux fixations de bagage.

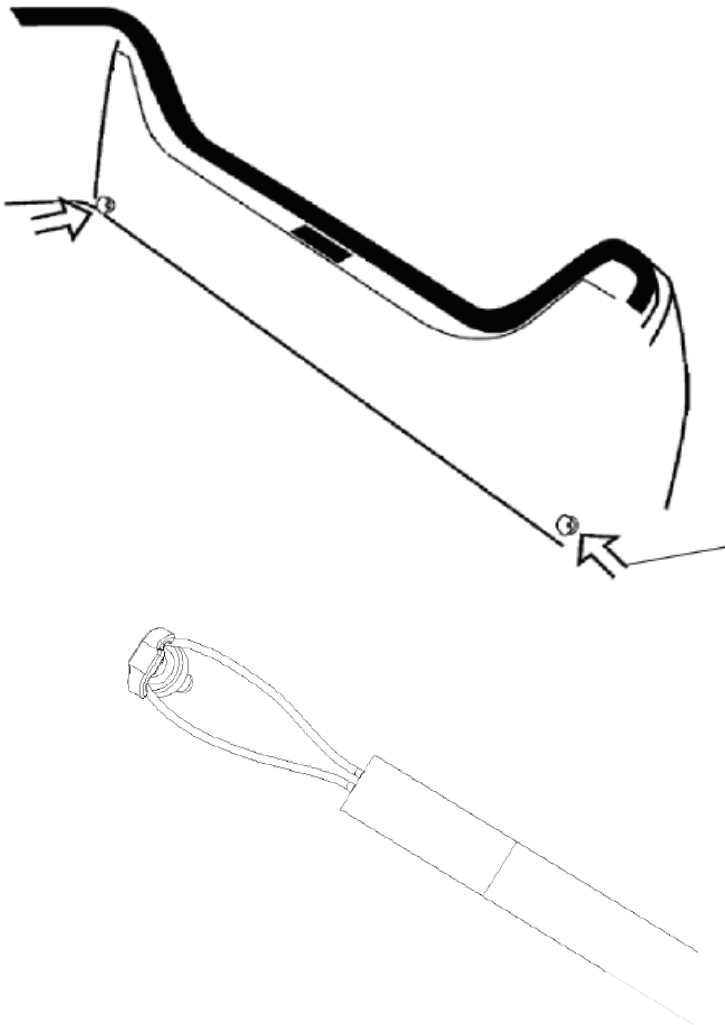

7. Pour ranger le module de chargement, détacher les parois et le dispositif de maintien ou la sangle des fixations de bagages afin de le replier, puis rebrancher la boucle afin de le maintenir en position fermée.

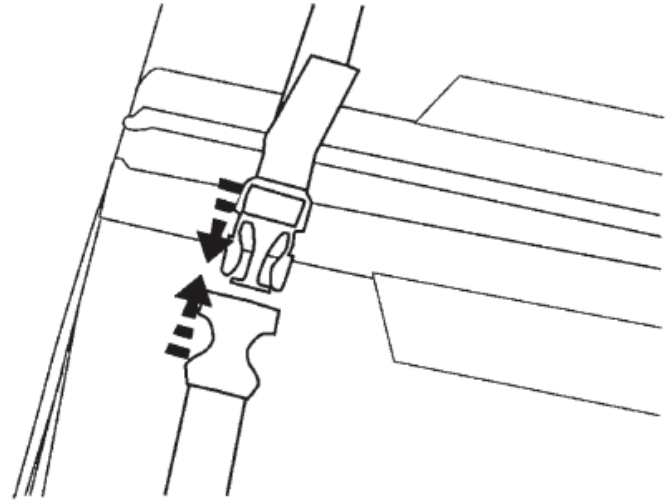

Collapsible Cargo Organizer

IR 21FE11

PART NO.

22827941

SHEET

4 OF 6

ALL INFORMATION WITHIN ABOVE BORDER TO BE PRINTED EXACTLY AS SHOWN ON 8.5 x 11 WHITE 16 POUND NON-BOND RECYCLABLE PAPER. PRINT ON BOTH SIDES, EXCLUDING TEMPLATES. TO BE UNITIZED IN ACCORDANCE WITH GM SPECIFICATIONS.

DATE	REVISION	AUTH	DR

TITLE

**INSTALLATION INSTRUCTIONS
Collapsible Cargo Organizer**

PART NO.

22827941

SHEET

4 OF 6

Organizador de carga plegable

1. Libere la hebilla para remover la correa que sostiene al organizador de carga cerrado.

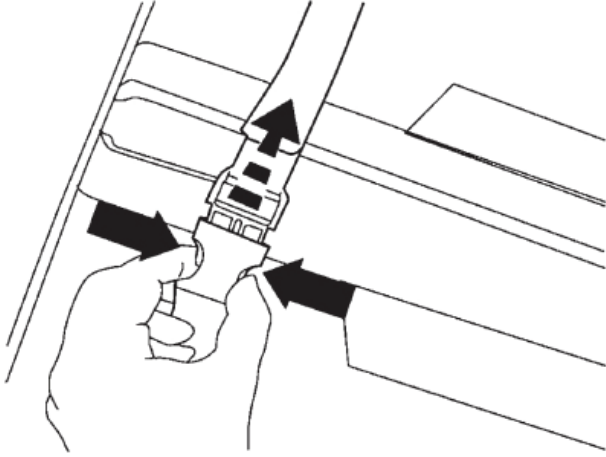

2. Abra el organizador de carga.

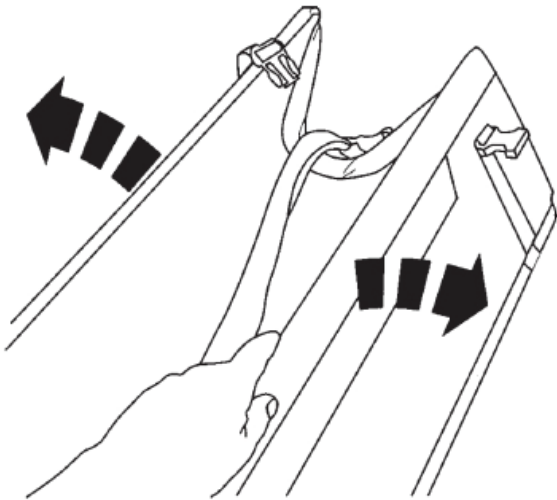

3. Levante las paredes plegables y utilice el velcro para sujetar las paredes por fuera de la caja para asegurar los compartimentos de adentro.

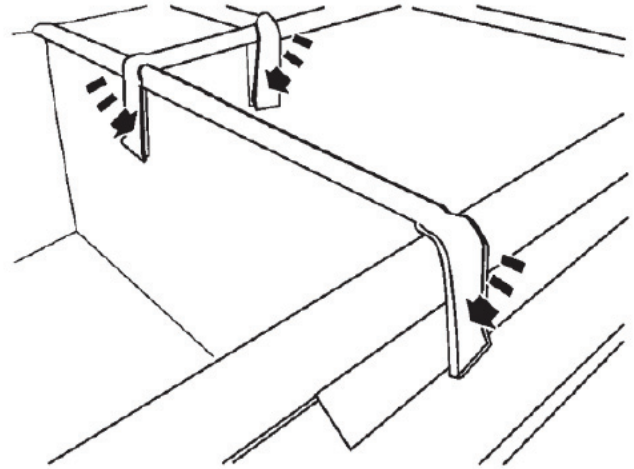

4. Retire el dispositivo de retención de ambos lados de la pared trasera del compartimento.

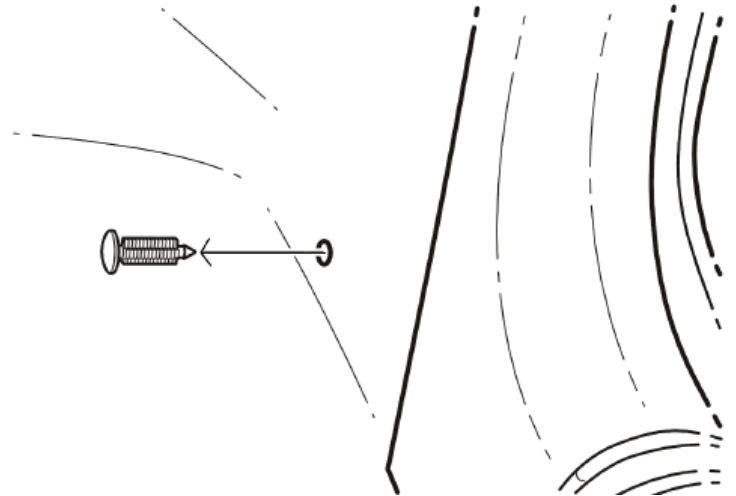

Collapsible Cargo Organizer

IR 21FE11

PART NO.

22827941

SHEET

5 OF 6

ALL INFORMATION WITHIN ABOVE BORDER TO BE PRINTED EXACTLY AS SHOWN ON 8.5 x 11 WHITE 16 POUND NON-BOND RECYCLABLE PAPER. PRINT ON BOTH SIDES, EXCLUDING TEMPLATES. TO BE UNITIZED IN ACCORDANCE WITH GM SPECIFICATIONS.

DATE	REVISION	AUTH	DR
21FE11	Initial Release - Jonathan Pacheco		

TITLE
INSTALLATION INSTRUCTIONS Collapsible Cargo Organizer
PART NO. 22827941 SHEET 5 OF 6

5. Instale el dispositivo de retención de equipaje en ambos lados de la pared trasera del compartimento.

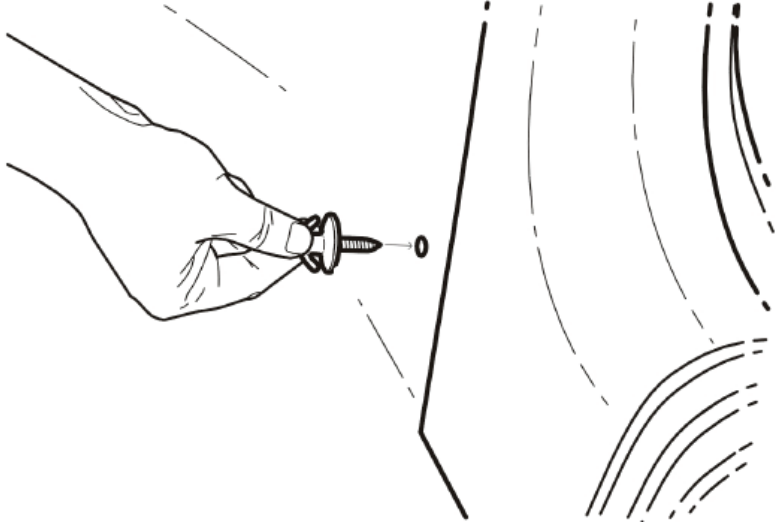

6. Coloque las tapas sobre los dispositivos de retención de equipaje.

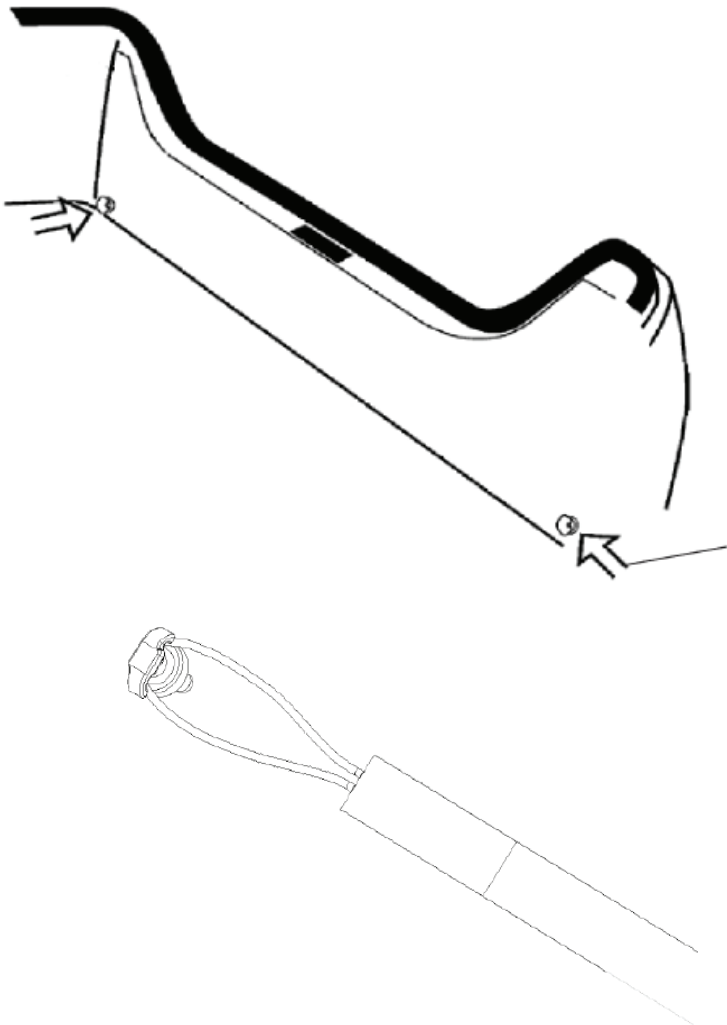

7. Para guardar el organizador de carga, despliegue las paredes y desate la correa o dispositivos de retención de equipaje para desmontar el organizador y ate nuevamente la hebilla para cerrar el organizador de carga.

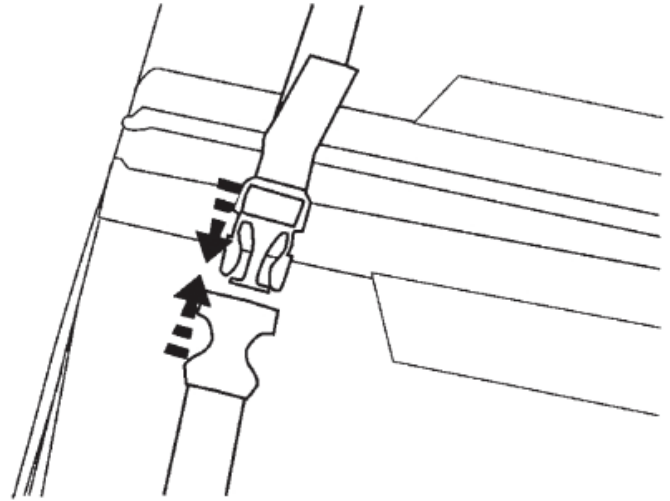

Collapsible Cargo Organizer

IR 21FE11

PART NO.

22827941

SHEET

6 OF 6

ALL INFORMATION WITHIN ABOVE BORDER TO BE PRINTED EXACTLY AS SHOWN ON 8.5 x 11 WHITE 16 POUND NON-BOND RECYCLABLE PAPER. PRINT ON BOTH SIDES, EXCLUDING TEMPLATES. TO BE UNITIZED IN ACCORDANCE WITH GM SPECIFICATIONS.

DATE	REVISION	AUTH	DR

TITLE

**INSTALLATION INSTRUCTIONS
Collapsible Cargo Organizer**

PART NO.

22827941

SHEET

6 OF 6