

Side Door Window Upper Air Deflector Package Installation (Crew Cab)

Installation Instructions Part Number

23294770

Side Door Window Upper Air Deflector Package Installation

DESCRIPTION	QUANTITY
Front RHS Stylevisor	1
Front LHS Stylevisor	1
Rear RHS Stylevisor	1
Rear LHS Stylevisor	1
Alcohol Prep Pad	4

Tools Required

Clean Soft Cloth, Ruler

Caution: Do not use abrasive, spirit or solvent-based cleaners.

[Installation](#)

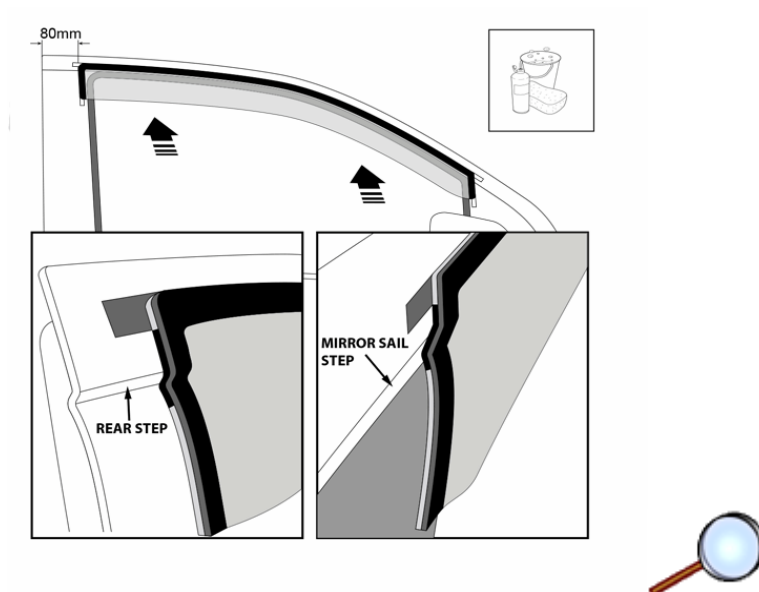

1. Trial fit the stylevisor to the front door. Do not expose tape during this step. Clean and dry the upper front door frame. Lower the window and trial fit the front stylevisor onto the door frame. Align the rear step of the stylevisor with the step in the door frame profile. Locate the

© 2014 General Motors. All rights reserved.

rear edge of the stylevisor 80mm from the rear edge of the of the door frame, as shown. Reference marking the 80mm with the masking tape can aid with alignment. Once alignment is correct, marking alignment and or final installation position with masking tape will assist in proper alignment when the stylevisor tape is exposed.

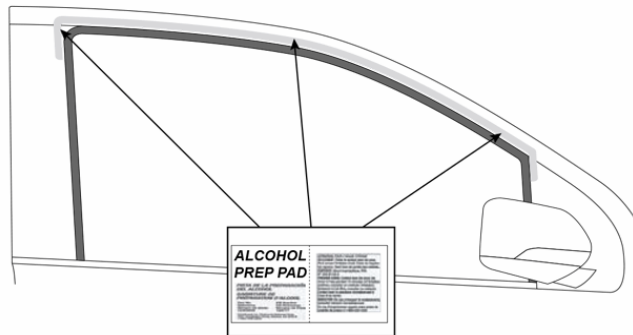

2. Clean the tape attachment areas on the door frame thoroughly with the alcohol prep pad provided. Wipe dry with a clean, dry cloth.

Important: Door frame must be clean prior to installing part on the door frame. Failure to clean will result in reduced tape adhesion to the door frame.

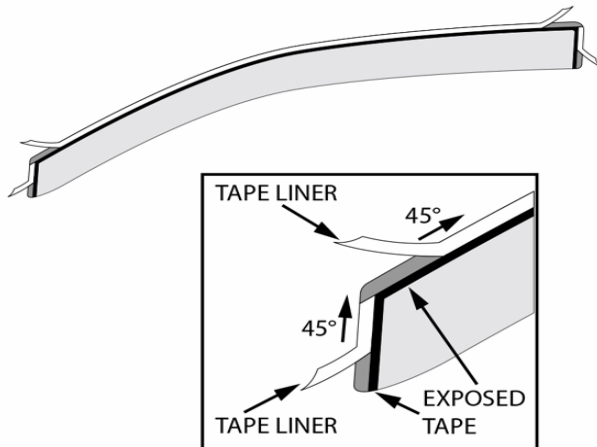

3. At the pull tabs peel back approximately 50mm (2") of the protective tape liner on the backing tape from each of the tape sections and fold the protective liner at 45° to the outside of the stylevisor.

Important: Do not touch the exposed surface of the backing tape.

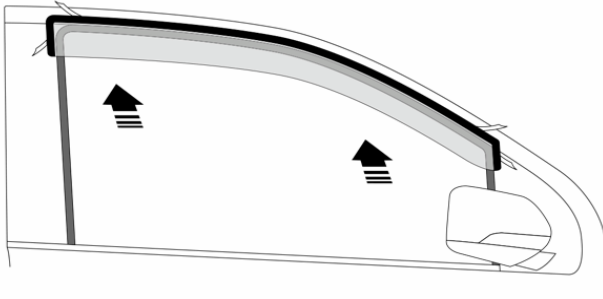

4. Position the stylevisor on the door frame. Double check the positioning of the stylevisor following the dimensions shown in step 1, then apply light pressure to the tape areas.

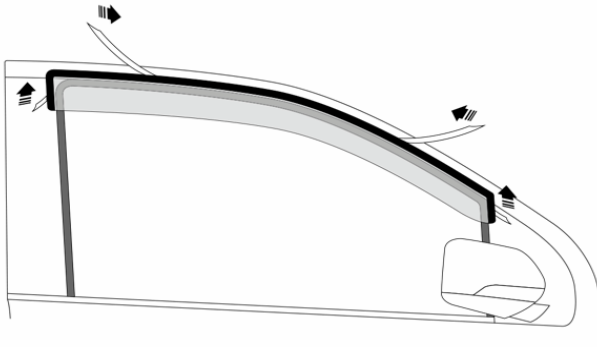

5. Slowly peel the remaining protective tape liner away by pulling on the exposed ends of liner, and apply firm pressure around the attachment areas.

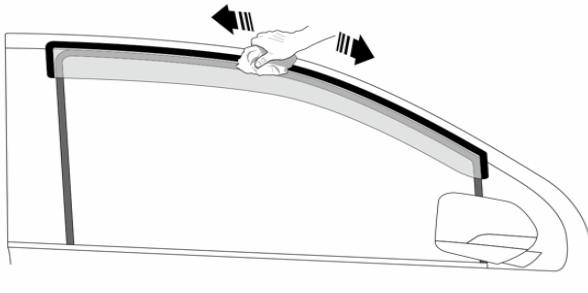

6. Using a clean, soft cloth, firmly rub down over the attachment areas 4 times to ensure maximum adhesion.

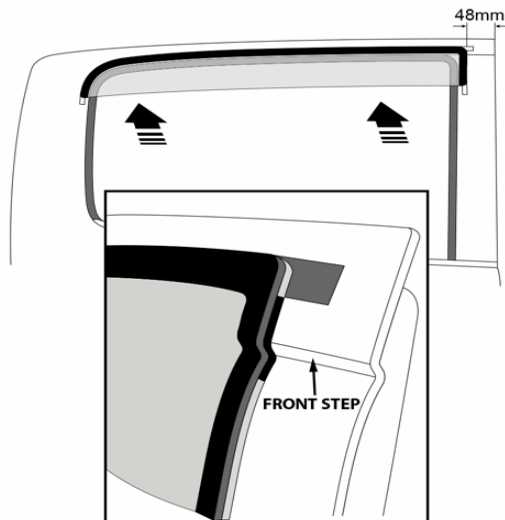

7. Trial fit the stylevisor to the rear door. Do not expose tape during this step. Clean and dry the upper rear door frame. Lower the window and trial fit the rear stylevisor onto the door frame. Align the front step of the stylevisor with the step in the door frame profile. Locate the front edge of the stylevisor 48mm from the front edge of the door frame, as shown. Reference marking the 48mm with masking tape can aid with alignment. Before tape liner removal and final installation make sure the stylevisor is aligned with the rear of the front door stylevisor. Once alignment is correct, marking alignment and or final installation position with masking tape will assist in proper alignment when the stylevisor tape is exposed.

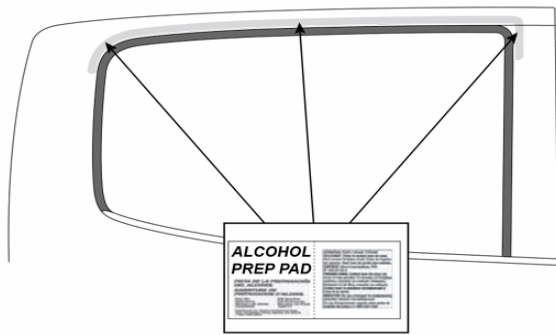

8. Clean the tape attachment areas on the door frame thoroughly with the alcohol prep pad provided. Wipe dry with a clean, dry cloth.

Important: Door frame must be clean prior to installing part on the door frame. Failure to clean will result in reduced tape adhesion to the door frame.

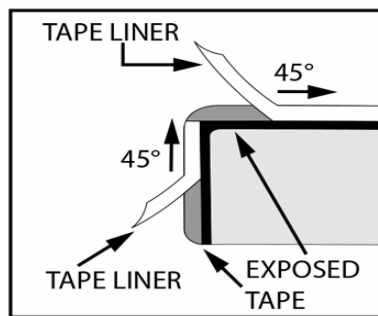

9. At the pull tabs peel back approximately 50mm (2") of the protective tape liner on the backing tape from each of the tape sections and fold the protective liner at 45° to the outside of the stylevisor.

Important: Do not touch the exposed surface of the backing tape.

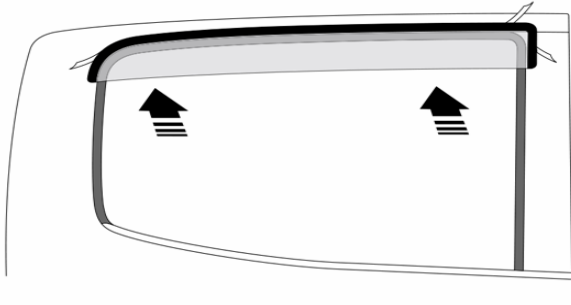

10. Position the stylevisor on the door frame. Double check the positioning of the stylevisor following the dimensions shown in step 7, then apply light pressure to the tape areas.

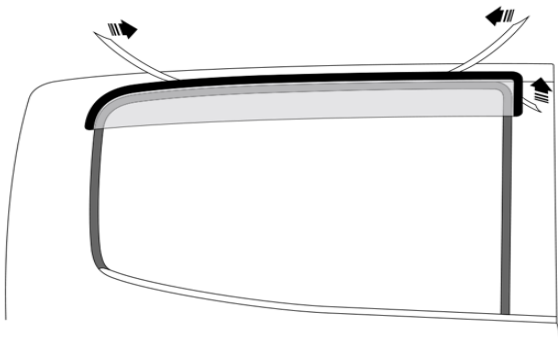

11. Slowly peel the remaining protective tape liner away by pulling on the exposed ends of liner, and apply firm pressure around the attachment areas.

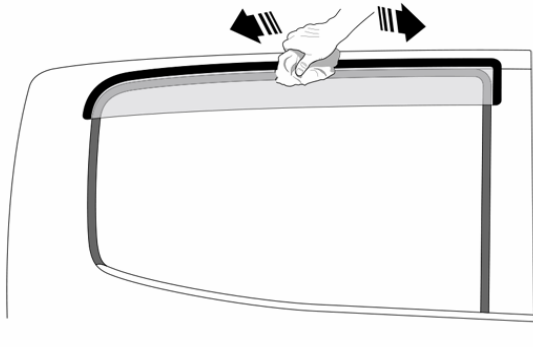

12. Using a clean, soft cloth, firmly rub down over the attachment areas 4 times to ensure maximum adhesion.