

# Front Fog Lamp Package Installation

## [Installation Instructions Part Number](#)

95262418

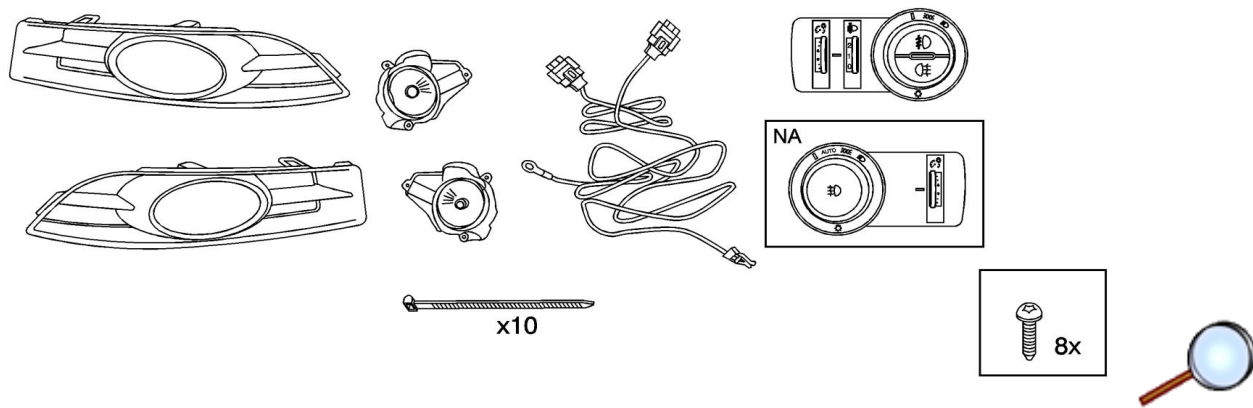

TORX T-20

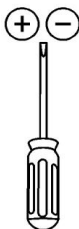
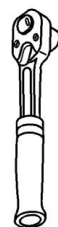
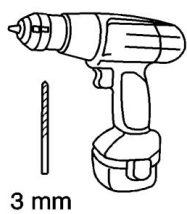

1

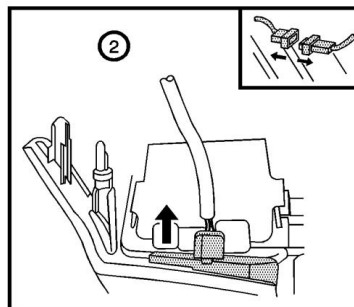
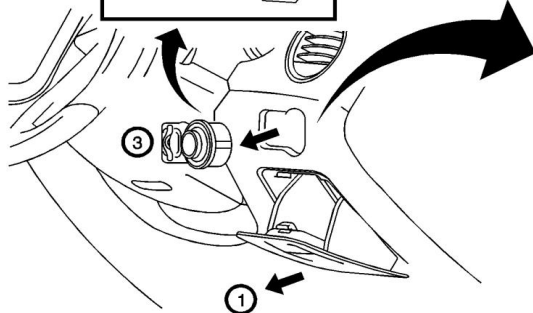
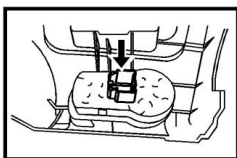

2

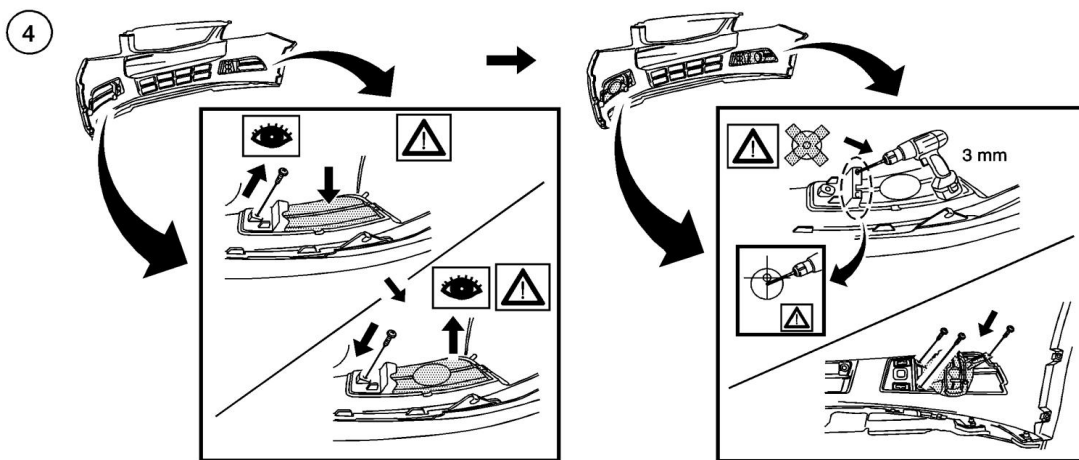
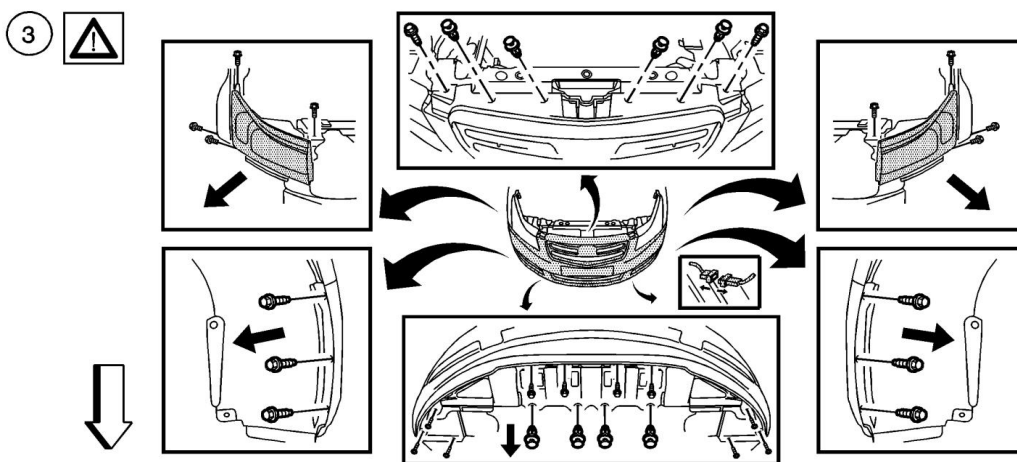
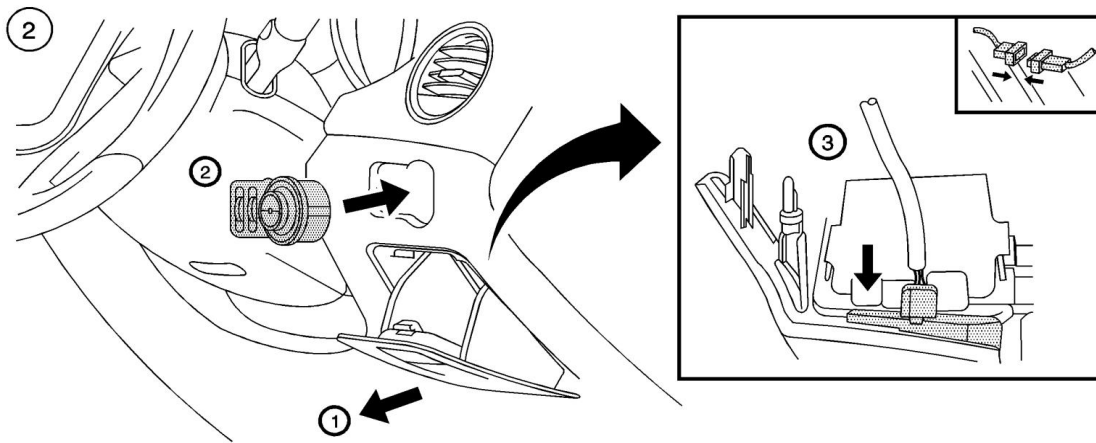

5

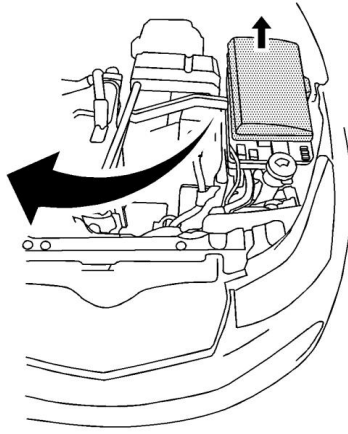
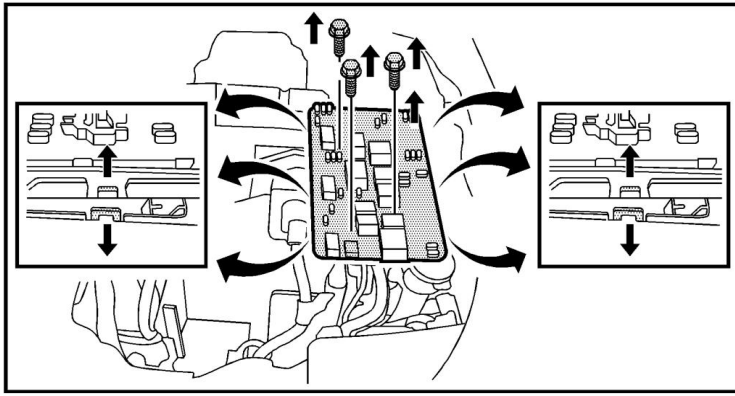

6

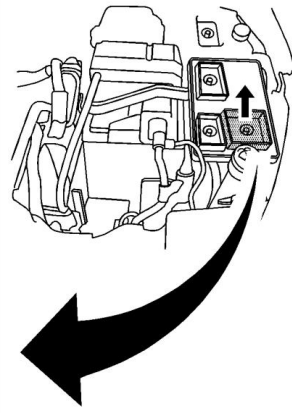
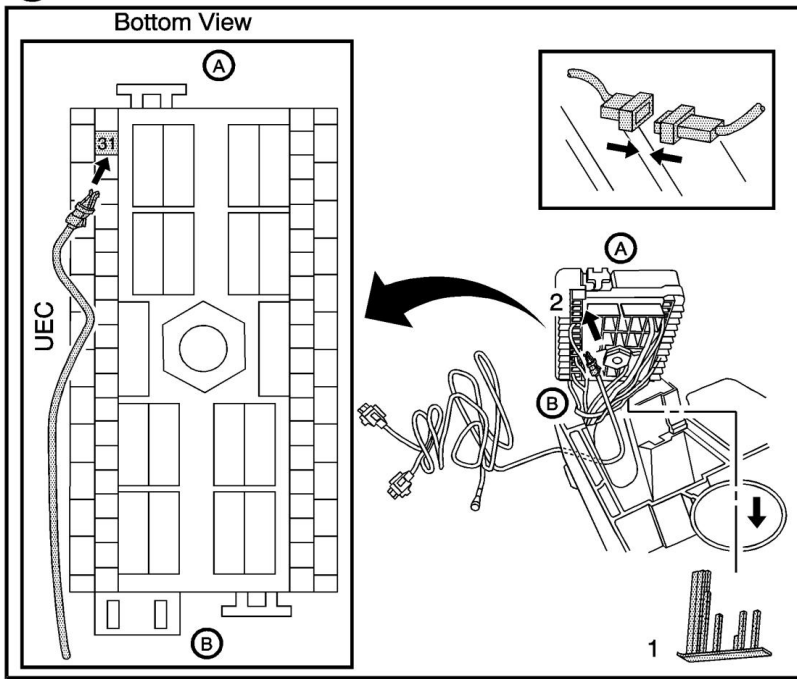

7

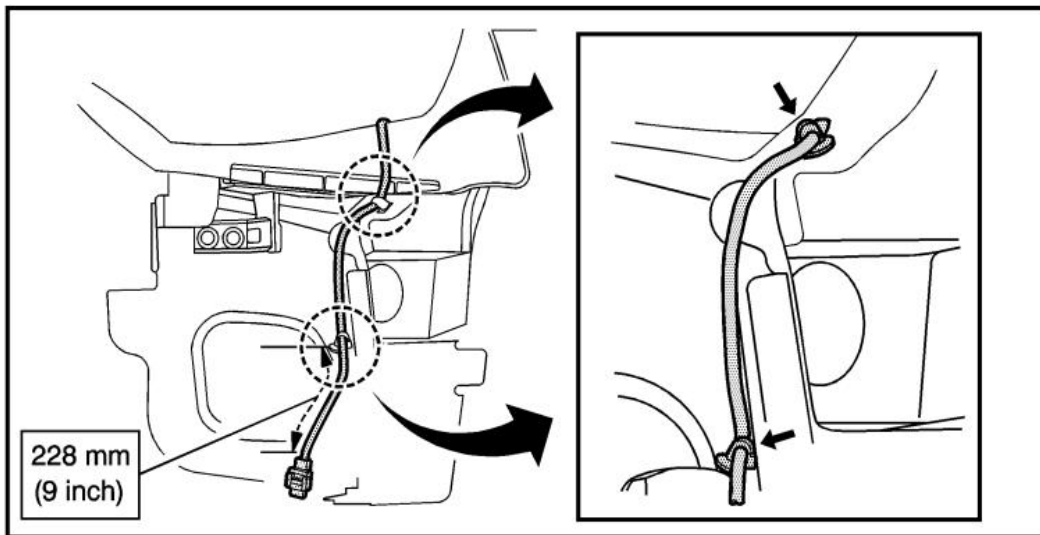
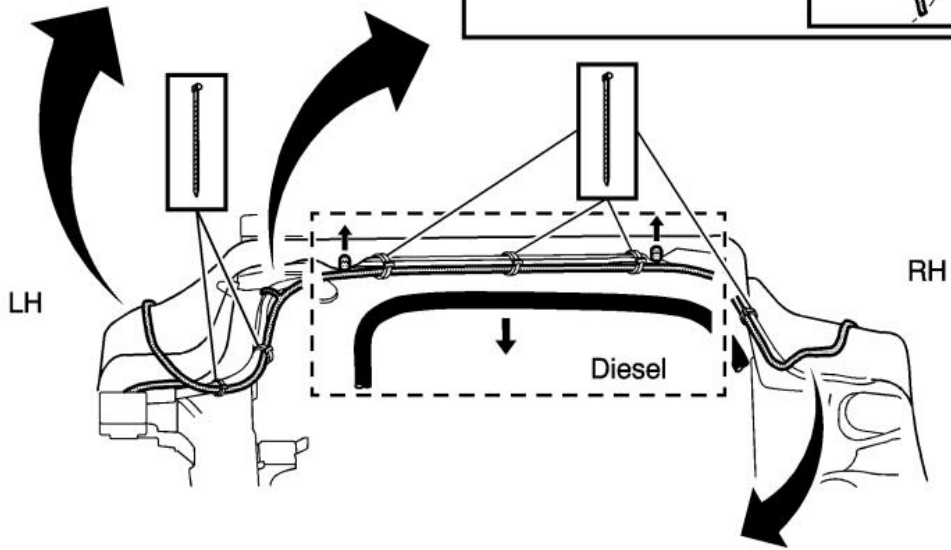
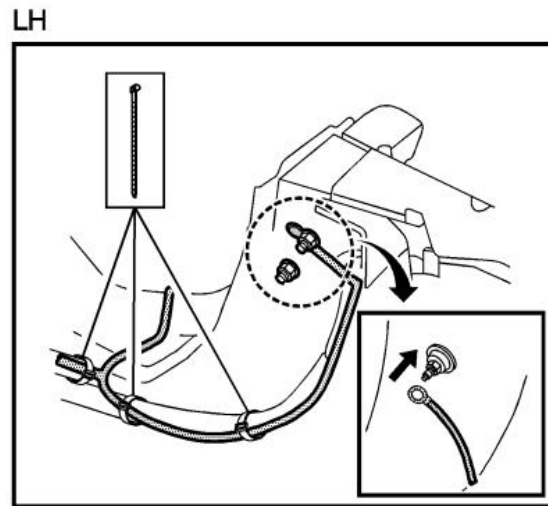
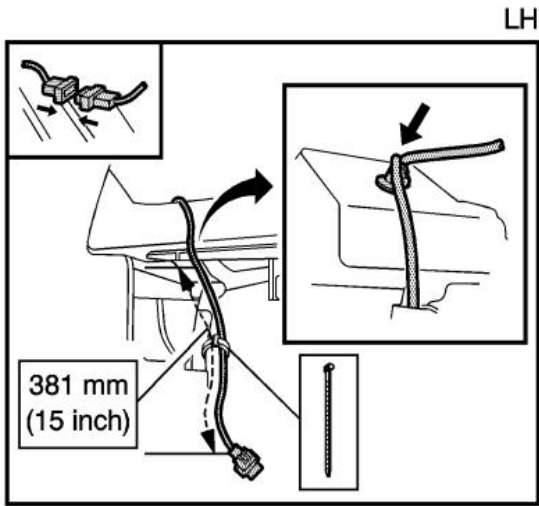

8

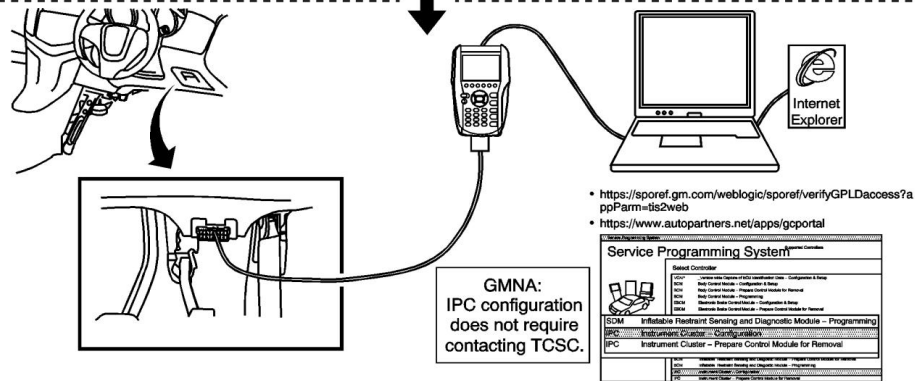
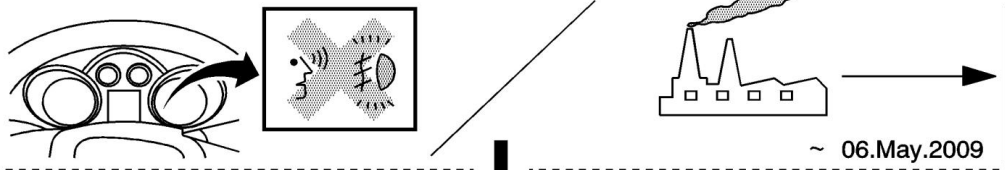
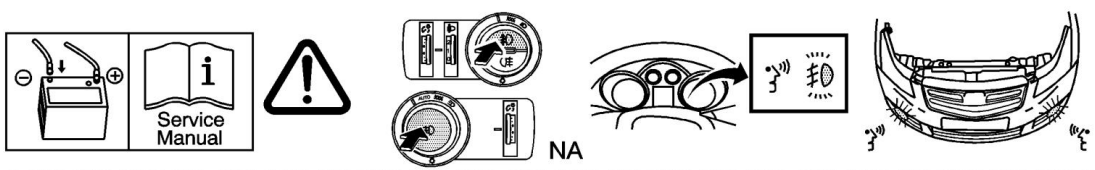
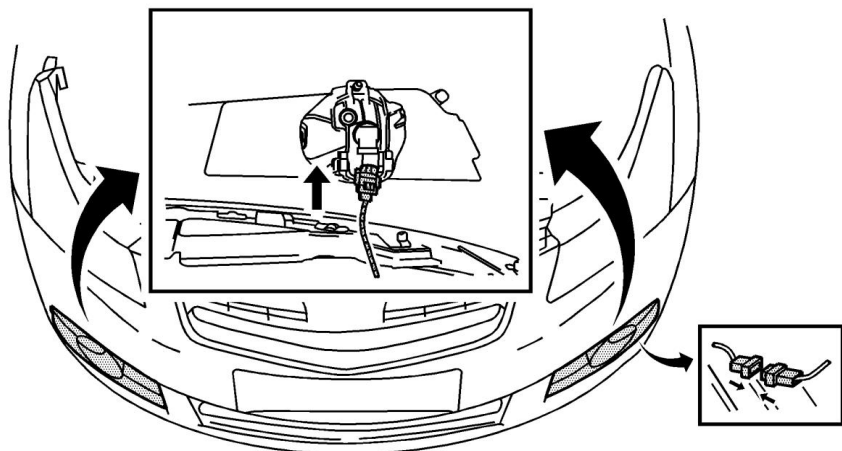

Note: See PI0910B: Accessory Fog Lamp Inoperative. Vehicles built after March 25, 2013 will not require the BCM to be re-programmed.

