

Hood Deflector

Very Important! Read all instructions before installation.

Kit Contents

Item	Components	Quantity
A	Hood Deflector	1
B	Alcohol Pad	2
C	Instruction Sheet	1
D	Set Screw	3
E	E-Bracket	3
F	Push Fastener	5
G	Bumpers	5
H	Allen Wrench	1
I	Protective Tape	5
J	Snap-In Bracket	2

Tools Required



CAUTION:

- A. Do not install when ambient temperature is below 60°F.
- B. Do not use solvents of any kind to clean deflector.

Installation Instructions

1. Wash the hood with mild soapy water and dry with a clean towel. See Figure 1.

FIGURE 1

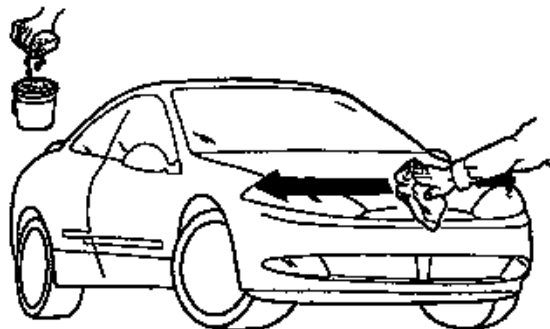

2. Install 5 brackets using the push fasteners into the holes located in the hood deflector. Inner holes use E-brackets, outer use Snap-in brackets. See Figure 2.

FIGURE 2

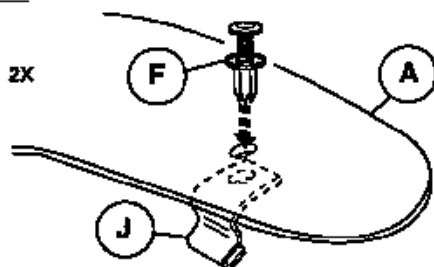

OUTER HOLE BRACKET ASSEMBLY

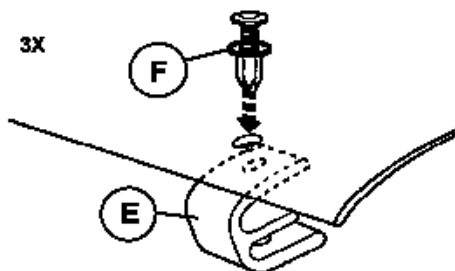

INNER HOLE BRACKET ASSEMBLY

3. Open Hood. Place hood deflector in position and mark the bracket locations with a marker. Then remove the hood deflector and install the clear protective film at each marked location. See Figure 3.

FIGURE 3

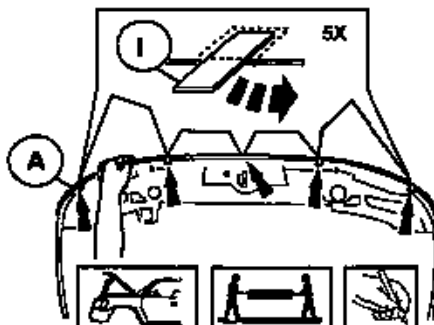

4. Re-install hood deflector. Attach 3 set screws into the E-brackets and slide Snap-in brackets into place. Do not over tighten set screws. See Figure 4.

FIGURE 4

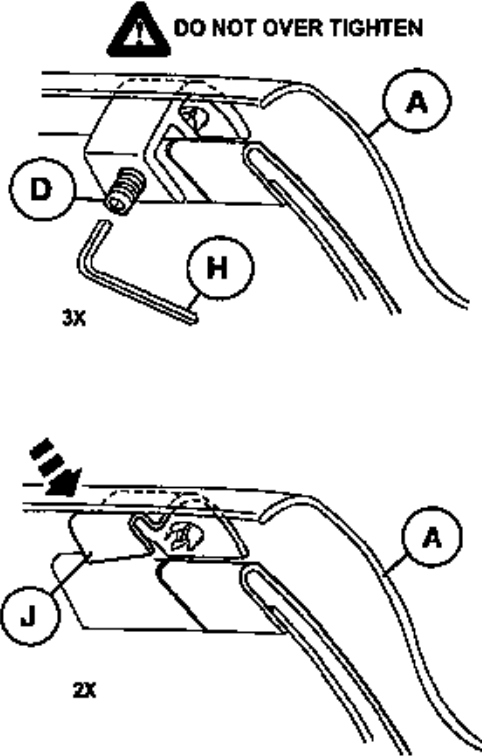

5. Using the alcohol pad, wipe clean the areas directly under the yellow dot locations on the hood deflector. Let air dry. See Figure 5.

FIGURE 5

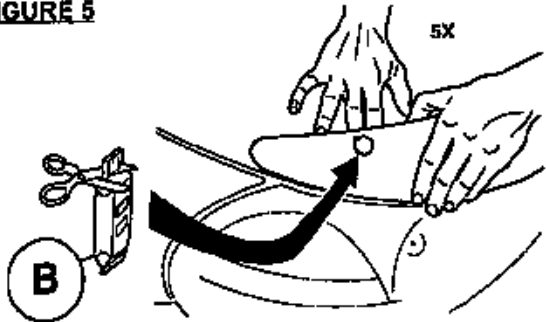

6. Next, stick a bumper under each yellow dot location; attach bumper ONLY to the hood, as shown. Peel and throw away the yellow dots when complete. See Figure 6.

FIGURE 6

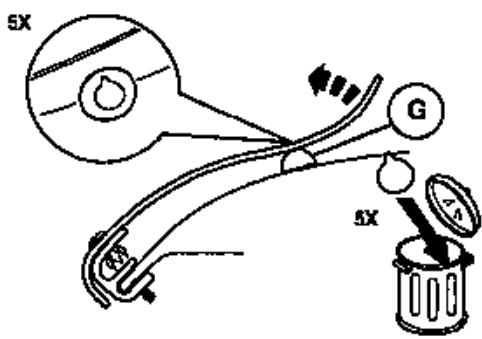



Déflecteur de capot

Très important | Lire toutes les directives avant de procéder à l'installation.

Contenu du nécessaire

Article	Composants	Quantité
A	Déflecteur de capot	1
B	Tampon d'alcool	2
C	Notice d'instructions	1
D	Vis de pression	3
E	Pince en E	3
F	Attache pression	5
G	Butoirs	5
H	Clé Allen	1
I	Ruban protecteur	5
J	Pince rapide	2

Outils requis



MISE EN GARDE :

- Ne pas installer lorsque la température ambiante est inférieure à 15,5 °C (60 °F).
- N'utiliser aucun solvant pour nettoyer le déflecteur.

Directives d'installation

- Laver le capot au savon doux et à l'eau, puis sécher avec une serviette propre. Voir la figure 1.

FIGURE 1

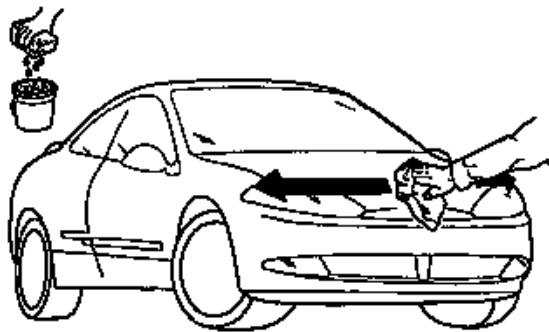

- Poser 5 pincés à l'aide des attaches pression dans les trous situés dans le déflecteur de capot. Les pincés en E sont utilisées dans les trous intérieurs et les pincés rapides sont utilisées à l'extérieur. Voir la figure 2.

FIGURE 2

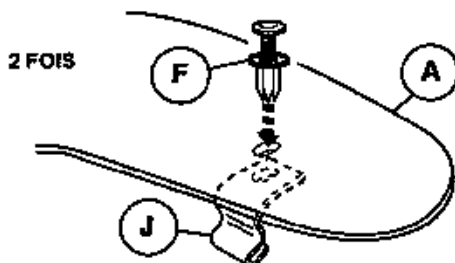

ENSEMBLE DE PINCE POUR TROU EXTÉRIEUR

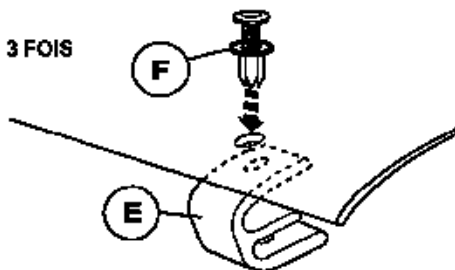

ENSEMBLE DE PINCE POUR TROU INTÉRIEUR

- Ouvrir le capot. Mettre le déflecteur de capot en position, puis marquer l'emplacement des pincés avec un marqueur. Enlever ensuite le déflecteur de capot, puis poser le ruban protecteur transparent à chaque emplacement marqué. Voir la figure 3.

FIGURE 3





4. Poser de nouveau le déflecteur de capot. Fixer 3 vis de pression dans les pincés en E, puis glisser en place les pincés rapides. Ne pas trop serrer les vis de pression. Voir la figure 4.

FIGURE 4

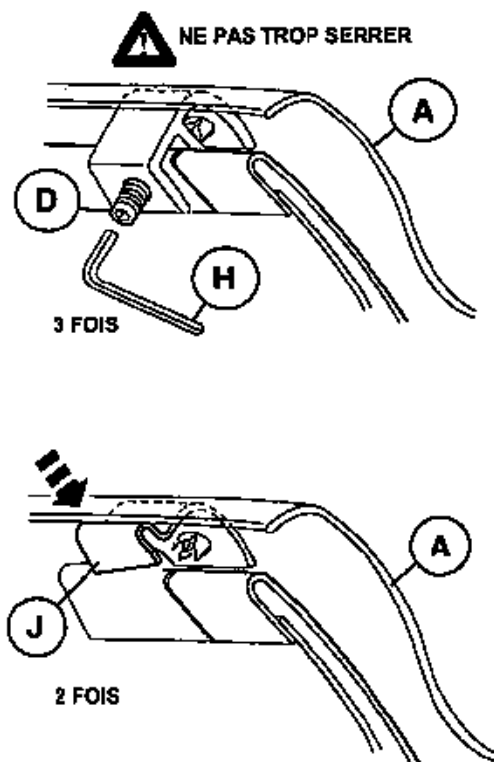

5. À l'aide du tampon d'alcool, nettoyer les zones directement sous les points jaunes sur le déflecteur de capot. Laisser sécher à l'air. Voir la figure 5.

FIGURE 5

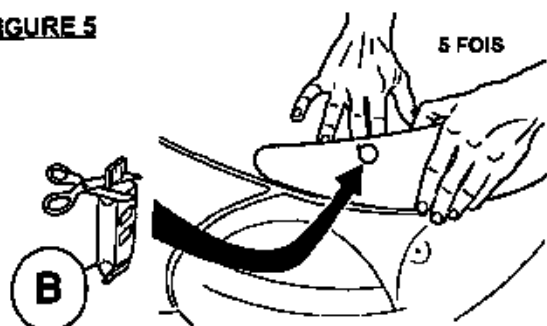

6. Ensuite, coller un butoir sous chaque point jaune ; fixer le butoir UNIQUEMENT sur le capot, conformément à l'illustration. Décoller les points jaunes et les jeter une fois l'opération terminée. Voir la figure 6.

FIGURE 6

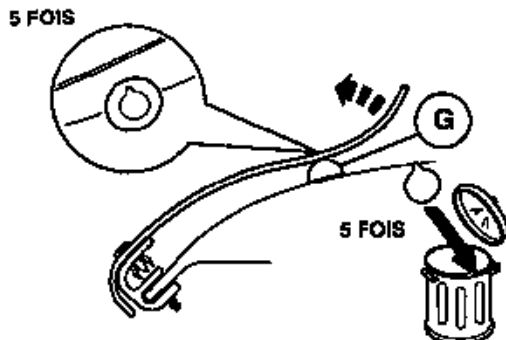



Deflector del capó

¡Muy importante! Lea todas las instrucciones antes de comenzar la instalación.

Contenido del juego

Artículo	Componentes	Cantidad
A	Deflector del capó	1
B	Limpiador con alcohol	2
C	Hoja de instrucciones	1
D	Tornillo de ajuste	3
E	Ménsula E	3
F	Sujetador tipo tachuela	5
G	Topes	5
H	Llave Allen	1
I	Cinta protectora	5
J	Ménsula de inserción	2

Herramientas requeridas



PRECAUCIÓN:

- A. No efectúe la instalación cuando la temperatura ambiente sea inferior a 15,5°C (60°F).
- B. No utilice solventes de ningún tipo para limpiar el deflector.

Instrucciones de instalación

1. Lave el capó con jabón suave y agua, y séquelo con una toalla limpia. Vea la Figura 1.

FIGURA 1

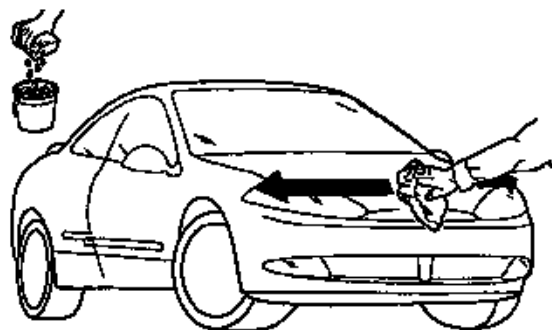

2. Instale 5 ménsulas en los orificios ubicados en el deflector del capó, usando los sujetadores tipo tachuela. En los orificios internos van las ménsulas E, y en los externos, las ménsulas de inserción. Vea la Figura 2.

FIGURA 2

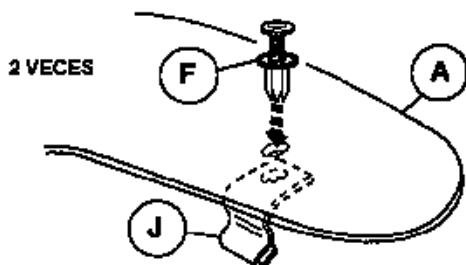

MÉNSULA DEL ORIFICIO EXTERNO

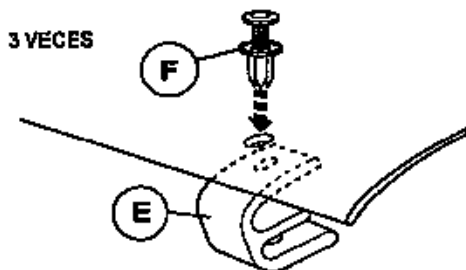

MÉNSULA DEL ORIFICIO INTERNO

3. Abra el capó. Coloque el deflector del capó en posición y marque las ubicaciones de las ménsulas con un marcador. Luego quite el deflector del capó e instale la película protectora transparente en cada ubicación marcada. Vea la Figura 3.

FIGURA 3

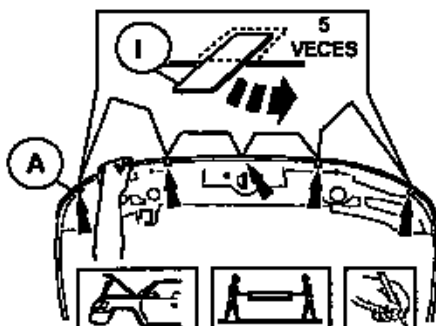

4. Vuelva a instalar el deflector del capó. Fije las ménsulas E con 3 tornillos de ajuste y deslice las ménsulas de inserción a su lugar. No apriete excesivamente los tornillos. Vea la Figura 4.

FIGURA 4

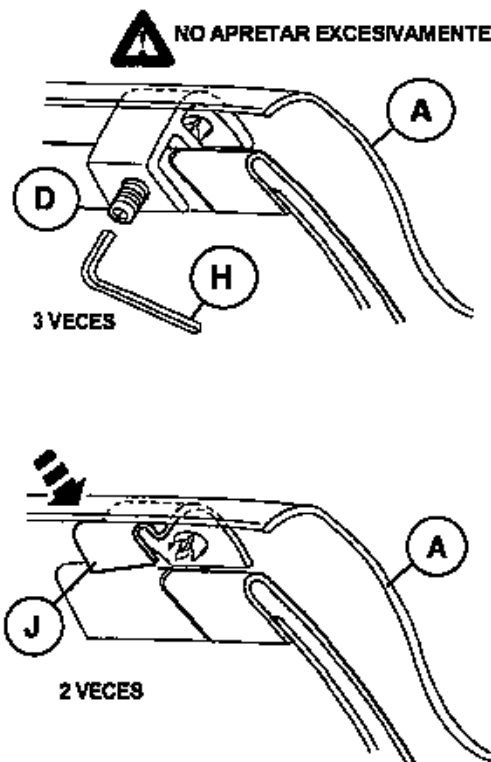

5. Usando el limpiador con alcohol, limpie bien las áreas directamente debajo de las ubicaciones con puntos amarillos en el deflector del capó. Deje secar al aire. Vea la Figura 5.

FIGURA 5

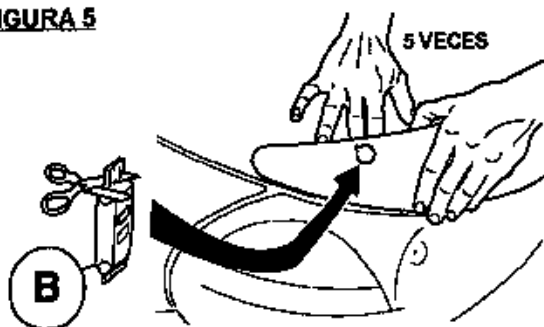

6. Luego pegue un tope debajo de cada ubicación de punto amarillo; adose el tope ÚNICAMENTE al capó, como se muestra. Cuando haya finalizado, retire y deseche los puntos amarillos. Vea la Figura 6.

FIGURA 6

5 VECES

